



CITTÀ

Bow Wall Hook

Bow Wall Hook	2 x Screws	2 x Wall Plugs
		

Tools Required Drill | Hammer | Screwdriver

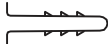
The maximum load-bearing weight of this hook depends on the surface it is fixed to and the method of installation. When installed into masonry or directly into a stud, the recommended maximum load is 6kg.

Note: For dry wall (GIB) installation, we recommend using high-quality and appropriate fixing anchors purchased from your local hardware store.

Step 1

Position the hook at the desired location on the wall. Using a pencil, mark the wall at the bottom of the hook.

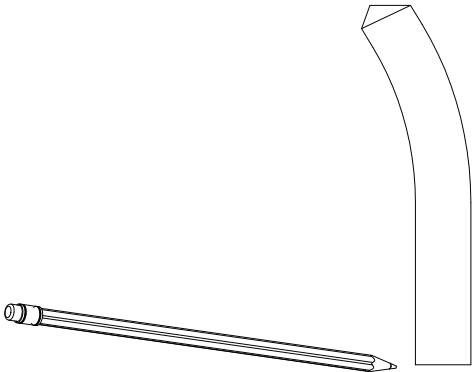

Step 2

Measure and mark points 2.5cm and 6cm above the initial pencil mark for the two screw holes. Confirm that the distance between these marks is 3.5cm, and ensure both marks are vertically aligned.

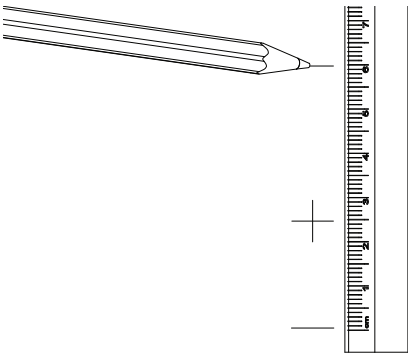

Step 3

Using a drill fitted with a 6mm drill bit, drill two holes at the marked screw hole positions.

If fixing directly into a stud, skip this step and proceed to Step 5.

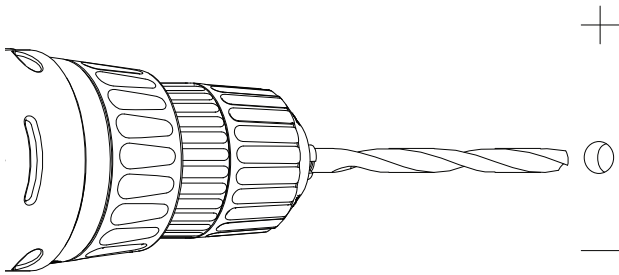

Step 4

Gently tap the wall plugs into the drilled holes until they sit flush with the wall surface.

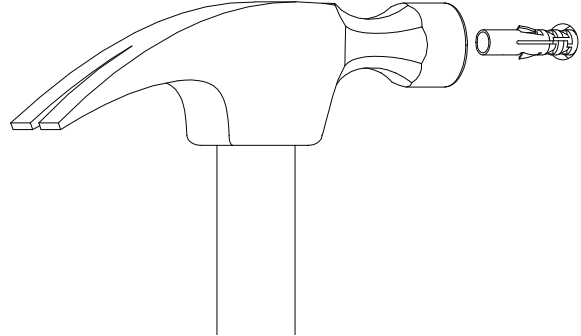

Step 5

Carefully screw the mounting screws into the wall plugs until the back of each screw head sits 5mm proud of the wall.



Step 6

Using the keyhole bracket on the back of the hook, fit the hook over the mounting screws, then carefully but firmly slide it downward to lock it into place.

Note: You may need to adjust the screw depth until the hook fits snugly and is securely fixed to the wall.

