

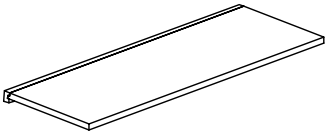

# CITTÀ

## Craft Buffet

Shelf x 4	Pin x 16
	

### Step 1

Tighten the shelf pins onto the cabinet where you want the shelf positioned.

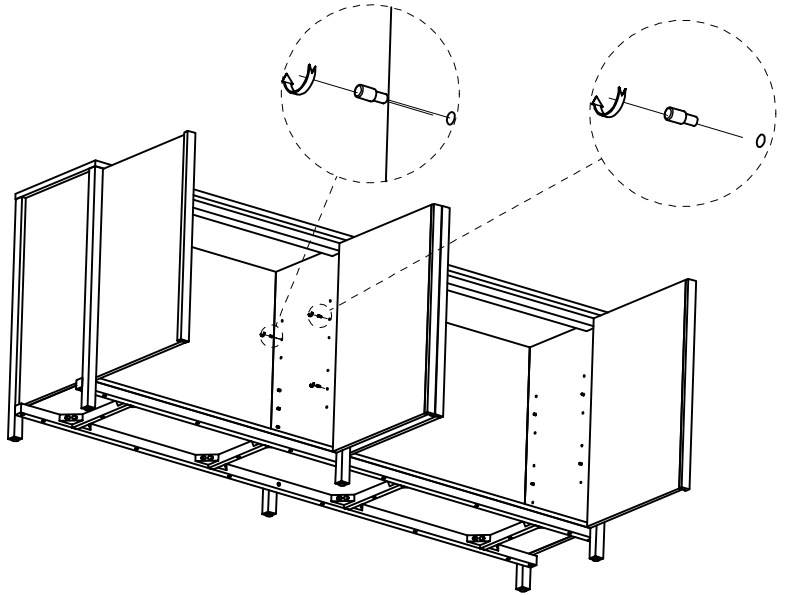

### Step 2

Place the shelves on the pins, the deeper solid timber shelf edge sits at the back of the cabinet.

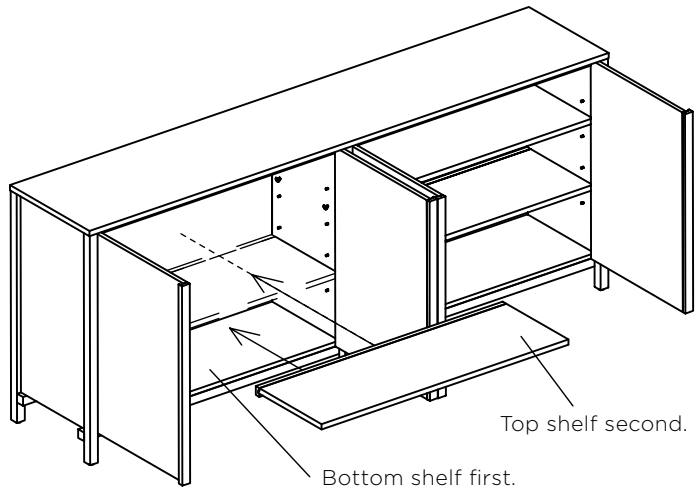

### Step 3

Install the anti tip restraint to the back of the cabinet using the instructions provided with the anti tip kit.

