

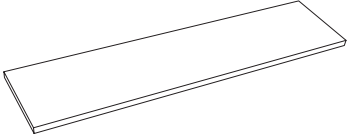

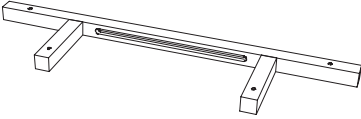
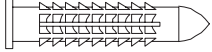

CITTÀ

Craft Floating Shelf Medium

Tools Required Drill
 Level

Parts Included

<p>H1 Shelf x 1</p>	<p>H2 Bracket x 1</p>	<p>H3 Wall Plug x 3</p>
		
<p>H4 Wall Screw x 3</p>	<p>H5 Hex Bolt x 4</p>	<p>H6 Allen Key x 1</p>
		

We recommend using a qualified builder or cabinetmaker for installation.

We always recommend fixing this shelf into studs, nogs or masonry. Ensure at least two screws are fixed into load bearing wall when installing.

*Note *If you are fixing some of the screws into dry wall (GIB), we recommend you purchase quality fixing anchors from your local hardware store.*

Step 1

Locate your bracket in the desired position and drill in the first wall screw. Use a level to ensure the bracket is straight before repeating for the remaining screws.

Ensure at least two screws are fixed into a stud, nog or masonry.

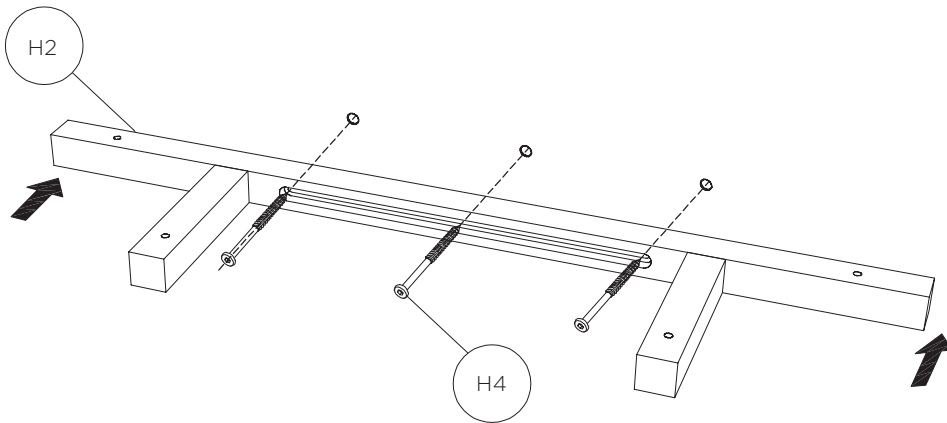

Step 2

Slot the shelf over the bracket and into place. Using the allen key and the hex bolts provided, screw the shelf to the bracket.

